

# Designing for Patient-Centeredness: the Design of Hemodialysis Equipment

Ching-Chiuan Yen\*     Martin S. Woolley\*\*

\* Department of Architecture, National University of Singapore  
e-mail:akiyc@nus.edu.sg

\*\* Department of Design, Goldsmiths College, University of London  
e-mail:martin@mwoolley.demon.co.uk

(Date Received :March 28,2002;Date Accepted :March 17,2003)

## Abstract

The aim of this study was to gain an insight into the use and application of patient-centeredness to medical equipment design. Hemodialysis (HD) equipment was therefore chosen as a 'case' to identify the differences in the end-products resulting from clinician-centered (traditional design methods) and patient-centered to design. The story of HD equipment evolution demonstrated that the design of HD equipment should be influenced not only by technology-push or/and market-pull but also by the needs of the patients or clinicians. The appropriateness of the patient-centeredness and its application to HD has also been identified in this study. Finally, the study suggests a radical change is required for the design of HD equipment. The learned lessons from the patient are the finest basis of discussion for how to get benefits back to the patient.

Keywords : Hemodialysis, patient-centered care, product design, user needs, case study

## 1.Introduction

Awareness of user/customer needs and preferences related to the product is one of the key elements in achieving successful product design [28, 25]. The notion that medicine should be closely congruent with and responsive to its customers' (patients) needs and preferences historically goes back to the early 1950s [29]. However, such a notion seems to conflict with the traditional 'doctor-centered' model of medical treatment [31, 16]. More recently, the notion of patient-centeredness has widely and rapidly spread throughout healthcare and as a result increasing emphasis has primarily been placed on meeting the expectations and demands of the patient [22, 17]. Growing consumer awareness is the main factor in this changing perception within healthcare. As the demand for patient satisfaction increases, the role of patient needs becomes increasingly important in

healthcare design.

Historically, medical equipment design was influenced mainly by the opinions of clinicians [1]. Several authors [32, 23] have stated that medical equipment needs not only to satisfy the demands of the clinicians, but should also satisfy the needs of the patient. This acknowledgement has resulted in the beginnings of a new design approach within healthcare as a whole. The methods employed in the design of medical equipment may also need to shift simultaneously from a clinician-centered approach, which focuses primarily on the diagnosis and treatment of diseases and clinician’s operational requirements, towards that of a patient-centered approach. This should ideally balance the patients’ needs and their preferences with those of the equipment operators and the intended medical functions. This balance would then lead to an improvement in the overall quality of clinical care and result in more mutually satisfactory treatment.

Based on the above notion, Yen [39] proposed a PCC design model (Figure 1), including 3 interactive elements:

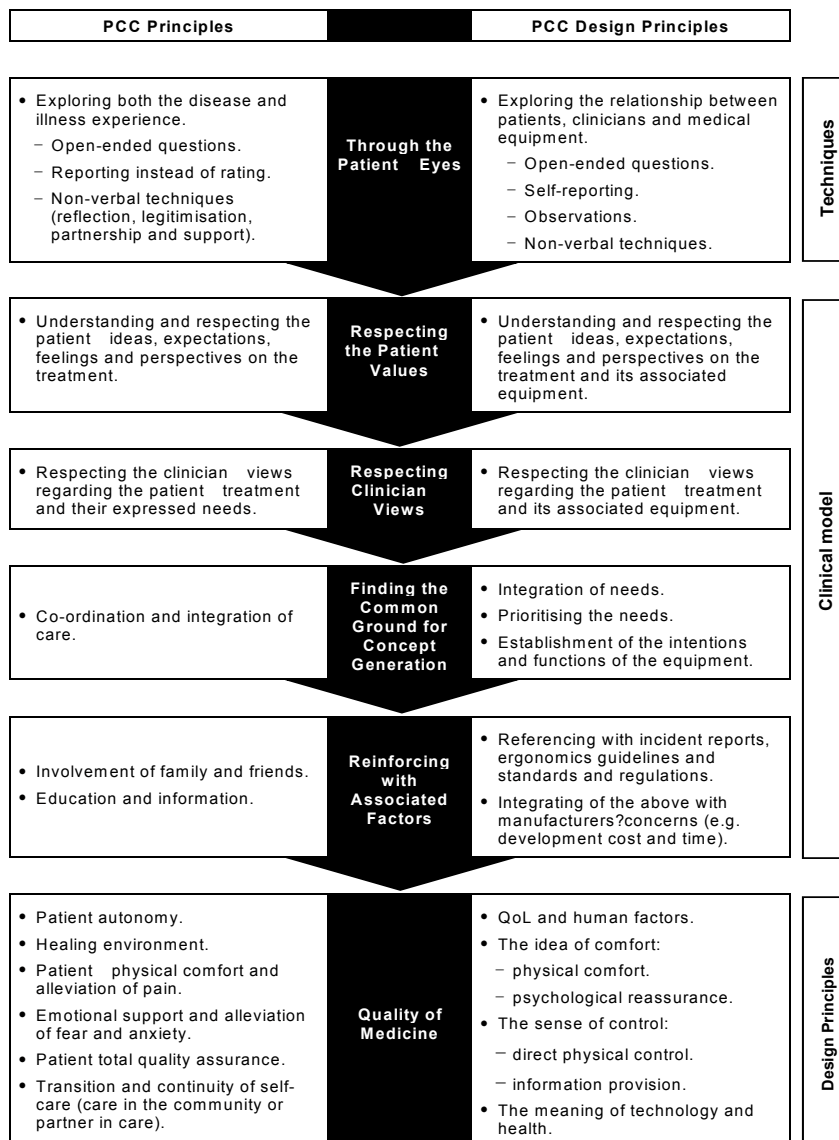

Figure 1. PCC design principles (Source: Yen [39] )

- techniques: the techniques for patient study to identify the underlying patient needs.
- clinical methods: clinical methods for designers to enhance the clinical decision-making.
- design principles: by using the dimensions as a ‘map’ to navigate the designers through the process of developing their products, in order to create more PCC outcomes.

The aim of this study was therefore to gain an insight into the use and application of the patient-centered design principles to the design of medical equipment. A case study was conducted to highlight how patient-centered principles enrich the design of medical equipment and the quality of associated patient care. Hemodialysis equipment (HD) has been chosen for the case study as it embodies many factors of contemporary significance. Firstly, HD is a relatively new and technologically advanced treatment in comparison to many other medical interventions. Its introduction and adoption, in addition to the potential for future developments in the treatment, has attracted a great deal of the attention from the medical community as a whole. Secondly, HD can reliably extend a patient’s life and as a result the effects of long-term use on patients, in terms of physical discomfort and psychological impacts been recorded [15, 18, 19]. Thus, the functions of the equipment not only meet the main medical mission, i.e. that of prolonging life, but should also improve the quality of patient life. Finally, dialysis has expanded the range of treatment options available to patients, including self-care, minimal care, and in-hospital treatment. Thus the patients are able to choose whether to be directly involved in administering their own treatment, or simply act a passive recipient, administrated by a clinician.

To understand such relationships in the design and use of HD, the development processes leading from the invention of the innovation to the diffusion and evolutionary development of HD equipment are examined in this study. The following have been investigated to direct this stage of study:

- the original motivation for the invention.
- the reasons behind a particular innovation arising at a particular time.
- the reasons for the success and failure of such innovations.
- who and what determines the direction of evolutionary development.

## **2.Research Methods and Materials**

The process by which the evidence gathered and analysis was structured as follows:

1. Background research into HD using published articles.
2. Case studies on the development of HD equipment, to identify patterns in the design strategies used. These case studies include retrospective studies of the development of HD equipment and interviews with manufacturers, patients, and clinicians on the design and use of HD equipment.
3. Comparative analysis includes an examination of individual case studies and a holistic overview across these to search for common patterns and issues.

Based on Yin’s research methods [38] for case study, six major sources were collected for the research as shown on Table 1. To obtain as accurate and reliable data as possible, two strategies,

theoretical propositions and case description, and a list of sequences for iterative nature of explanation-building used by Yin [38] were adopted in data analysis which are shown as follows:

- Repeating process as many times making an initial theoretical statement or an initial proposition.
- Comparing the findings of an initial case against such a statement or proposition.
- Revising the statement or proposition.
- Again revising the statement or proposition.
- Comparing the revision to the facts of a second, third or more cases.
- Repeating as it is required.

Table 1 Sources of the Case Study

<i>Documentation:</i>	Communication: letters, memos. Equipment operational menus. Equipment evaluation reports. Information on relevant equipment study. Information from mass media sources. Company reports.
<i>Archive:</i>	History regarding HD development. Survey data: information previously collected about the HD equipment. Personal records: diaries, telephone, conversations, etc.
<i>Interviews:</i>	An open-ended interview ('unstructured') with patients. A focused interview ('semi-structured') with clinicians.
<i>Direct Observation:</i>	The processes of dialysis.
<i>Questionnaire:</i>	A structured questionnaire sent to manufacturers.
<i>Physical artefacts:</i>	HD equipment.

## 3.The Evolution of HD Equipment

### 3-1 An Introduction of HD Equipment

HD equipment is a machine together with a dialyser, which prepares and checks the dialysate and circulates both dialysate and blood through the dialyser to the patient. A conventional system can be divided into several components as follows (Figure 2):

- Extracorporeal blood circuit: includes an access device (cannula or internal arteriovenous fistula) and blood line (arterial and venous bloodlines).
- Dialyser: where diffusion, osmosis and ultrafiltration occur.
- Control and monitoring system.
- Dialysate preparation.

A typical dialysis set-up starting from the arterial needle in the AV (Arteriovenous) shunt of the patient and back to the venous needle is shown schematically in Figure 2. The blood of the patient passes to the dialysis machine, through the filter and back to the patient. In the dialysis machine, a solution on the other side of the filter receives the waste products from the patient via osmotic filtration. As the machine becomes more complicated and sophisticated, the monitoring function

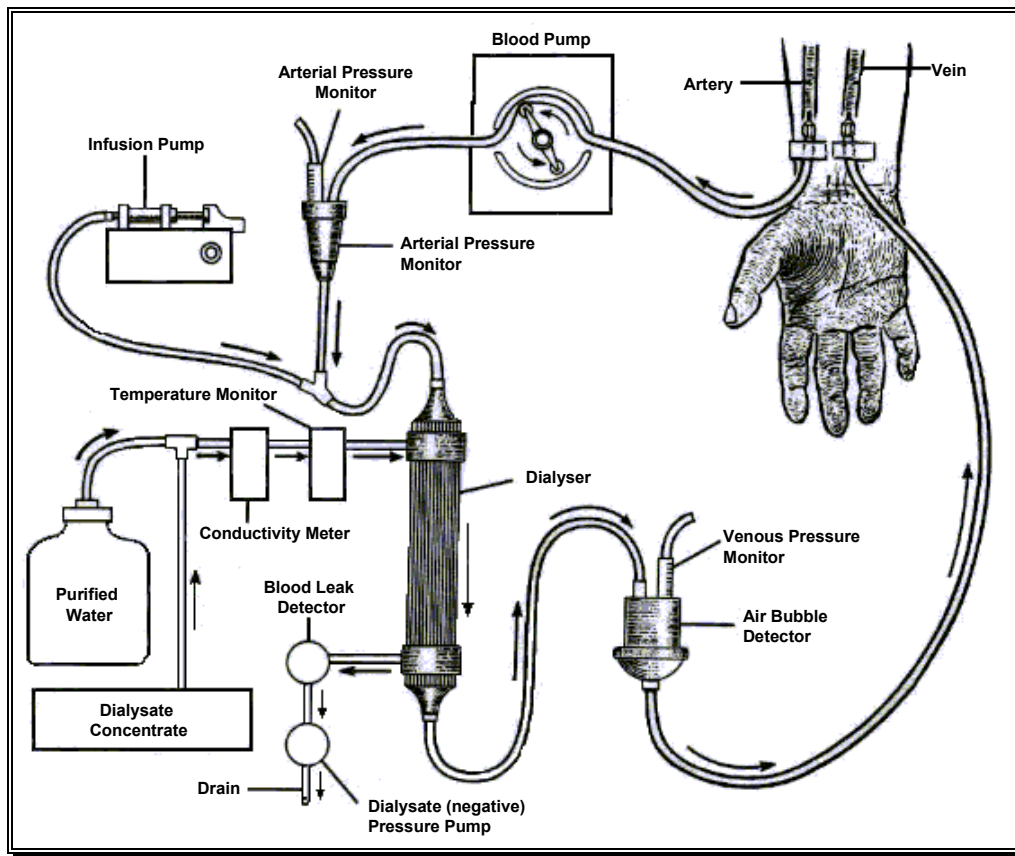

Figure 2. Components of a Haemodialysis System (Source: Brundage [3].)

becomes more crucial. Consequently, the effective interaction between equipment and users (clinicians and patient-users) becomes even more vital.

In order to appreciate the nature of HD equipment and its influence on patients, it is important to consider its historical context.

### 3-2 The Invention of the Dialysis Concept and Early Stages of Development

The concept of ‘dialysis’ which removes solutes from fluids by using diffusion across a physical membrane via osmosis, was demonstrated in the mid-19th century by Thomas Graham [12]. He believed that this finding might prove to be of biological significance. However, this concept did not proceed directly into the field of medicine as Graham was a chemist by profession.

Conventional dialysis equipment is an assembly of numerous components. Hardly any of these components existed at the time that Graham’s concept originated. Most were invented, developed and evolved during a 60-year period of invention and innovation started by Abel around the beginning of 1910, some 50 years after Graham’s original dialysis concept.

In 1912, Abel and his colleagues [12] were the first to experiment with such a concept on living animals and predicted that such a method may “[relieve] the kidney of human beings in certain pathological conditions.” In their experiments, the blood flowed directly from artery, to a dialyser,

and to a vein without an external blood pump. They coined the term ‘artificial kidney’ for their dialyser. Abel’s findings were warmly received. Nevertheless, his follow-up work was minimal, achieved limited results and his work only used animal subjects.

### 3-2.1 The first human application

Credit for the first human dialysis goes to Dr. Hass in Germany, who between 1924 and 1928 used the process on patients with terminal uraemia [26]. The machine built by him was similar to Abel’s apparatus, although unlike Abel’s, it had a mechanical blood pump in the arterial line before the dialyser. Notably, this machine included almost all of the components found in modern machines, although as individual, non-integrated items (Figure 3). Improvements in his patients’ clinical state was demonstrated during the experiment and he stated that “it looks very promising to continue and develop methods for improved ‘washings of the blood’ [9]”. Although numerous studies were conducted regarding dialysis during that period of time, most research focused on experimentation on the materials used in making the dialyser membrane and the methods of anticoagulation, in order to test the technical feasibility of ‘dialysis methods’ for human application. This demonstrated a design divergence which focuses on the development of discrete components and not the devices as a whole. As the technical problems were plentiful, the ‘dialysis machine’ was only built by pioneering physicians for the sole purpose of experimentation, not treatment and was therefore not commercialized.

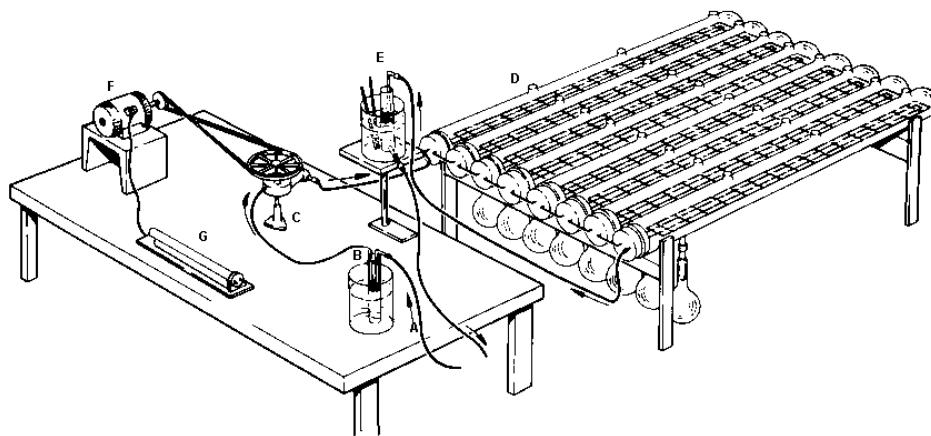

Figure 3. The Dialysis Machine Used by Dr. Hass [12]

A. Arterial bloodline, B. Arterial Blood Container, C. Blood Pump, D. Dialysers, E. Venous Blood Collector.

### 3-2.2 The First Commercial HD Machine

Credit for the invention of the first ‘commercial machine’ has been given to a young Dutch physician, Dr. Kolff. A ‘rotating drum’ dialyser (Figure 4), the first artificial kidney practical for human use, was introduced by him in the 1940s. The concept of the construction was copied from that of a Ford automobile water-pump that kept the lower half of the rotating drum immersed in

dialysis fluid [12].

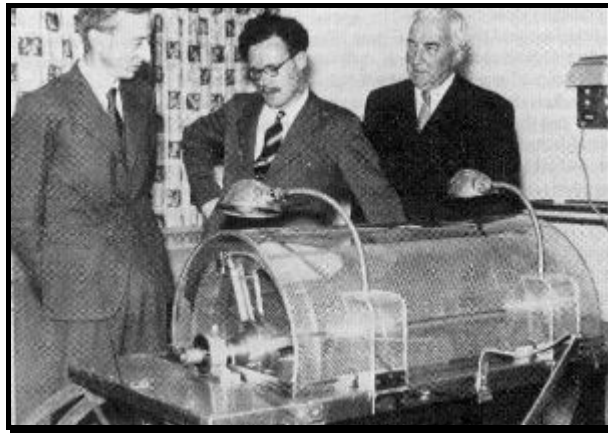

Figure 4. Kolff's Rotating Artificial Kidney and the Rotating Joint Based on a Ford Automobile Waterpump [16]

In 1955, the first commercial, 'twin coil' artificial kidney (Figure 5) HD machine, based on the work of Dr. Kolff, was developed and produced by Baxter Travenol Laboratories, Inc. in the US and rapidly gained popularity in Europe and America. Prior to the development of this machine, Baxter doubted the use of HD. Cody [10] mentioned that "although there was a medical need, no one could figure out how to make a market out of the need." This machine was designed to fulfill numerous potential medical requirements (e.g. the dialyser itself was compact and could be pre-sterilized by steam or by ethylene oxide. It was also disposable, relatively cheap and could be mass produced.). However, several operational and technical problems occurred. Experience and a great deal of skill was also required to operate such a machine. The 'technical feasibility' of the artificial kidney was the sole focus of design effort [11]. Although the HD equipment was for medical purposes, it was visually still very much like a piece of industrial equipment. Two examples, previously mentioned, are Kolff's 'water-pump' rotating drum dialyser (Figure 4) and the 'pressure cooker-like' 'twin coil' dialysis machine (Figure 5). The invention of Quinton's arterial ventricular shunt in 1960 opened the door for the regular use of HD as a long term replacement of renal function and brought the new era of regular dialysis even closer. Subsequent to this, the development of HD equipment has split into two factions which are presented in the following sections.

### 3-3 Design Convergence: The Development of Conventional Equipment

#### 3-3.1 Integration of equipment

Although the concept of HD was relatively mature by the 1960s', the machines were still poorly built. The system required a separate blood pump, heparin pump, air embolism protector and an additional pressure monitor. With the inclusion of the dialyser and blood tubing set, this led to the more complex setup of the modern system. In 1972, the Cobe Centry 2 (Figure 6), the first machine which integrated all components into a single package was introduced. The advantage and design

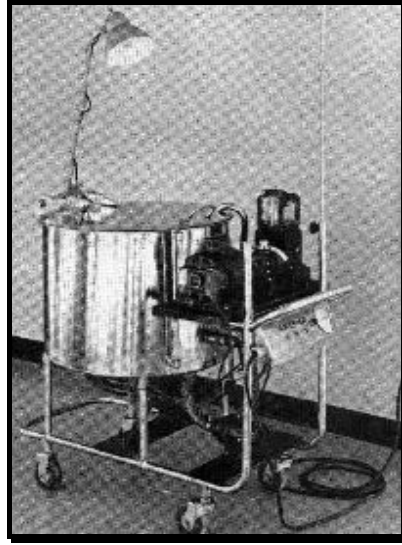

Figure 5. The First Commercial Machine [16]

objectives of this machine were serviceability, reliability and cost reduction and to promote the use of HD treatment [4]. Clinical efficiency was still the main focus. The ‘industrial box’, which houses all components, became the most popular form for the machine. Figure 6 demonstrates numerous examples which have a similar appearance. In 1977, Gambro launched the world’s first computer-controlled dialysis machine, AK-10 (Figure 7). Dialysis equipment had entered the era of computerization. The ‘modular’ design concept was applied to meet a variety of clinical needs and treatment modalities by expanding or modifying the interchangeability of components. Instead of the previous industrial aesthetic, a ‘stereo-like’ appearance was introduced which tried to provide a more patient-friendly appearance. However, difficulties occurred during the assembly and maintenance of the machines due to the over-complicated design.

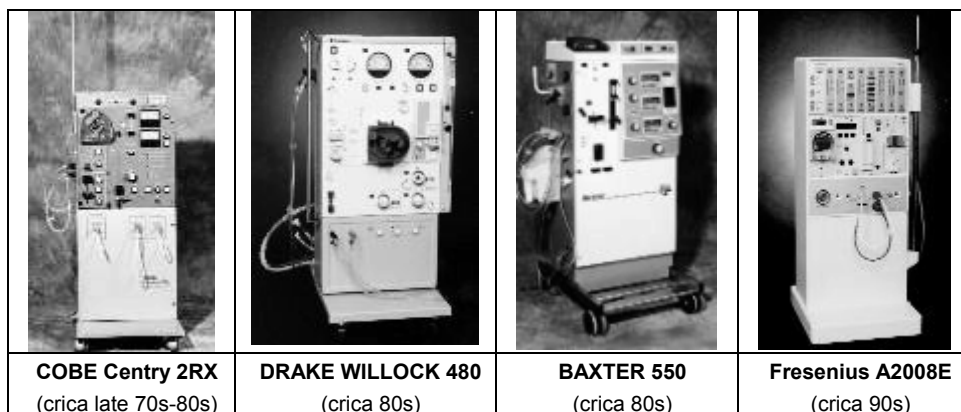

Figure 6. Examples of Conventional HD Machines

### 3-3.2 Computerization

During the 1980s and in subsequent Gambro’s machine, the design emphasis changed from



mechanical to analogue electronics and then to digital electronics. The microprocessor took over the machine control functions and computer displays appeared on the machine which became somewhat of a fashion icon (Figure 7). At this time, special features began to appear aimed at maintaining the patient in a more holistic and integrated manner. For example, a body temperature control system, a recirculation measuring device and an in vivo clearance tester were introduced by Fresenius. A blood volume measurement system was also introduced by Althin. The integration of medical data management systems was introduced as a consequence of the computerization of the equipment. The developments seemed to be ‘high-tech’ driven and independent of actual user needs. Most concept designs were introduced in the hope of finding a market. However, as the market began to be controlled by a small number of manufacturers, the shift in controlling power moved from the clinicians to the companies regarding design features incorporated into the new machines. It is also interesting to note that the price of machines has increased dramatically since the introduction of computerization to HD equipment. Boag [4] asks “why machine electronics became so much more complex and expensive with the introduction of microprocessor control?”

### 3-4 Design Divergence

In parallel with the incremental development of conventional HD equipment and associated components, amazing varieties of design were introduced to meet the needs of patients undergoing various treatment modalities.

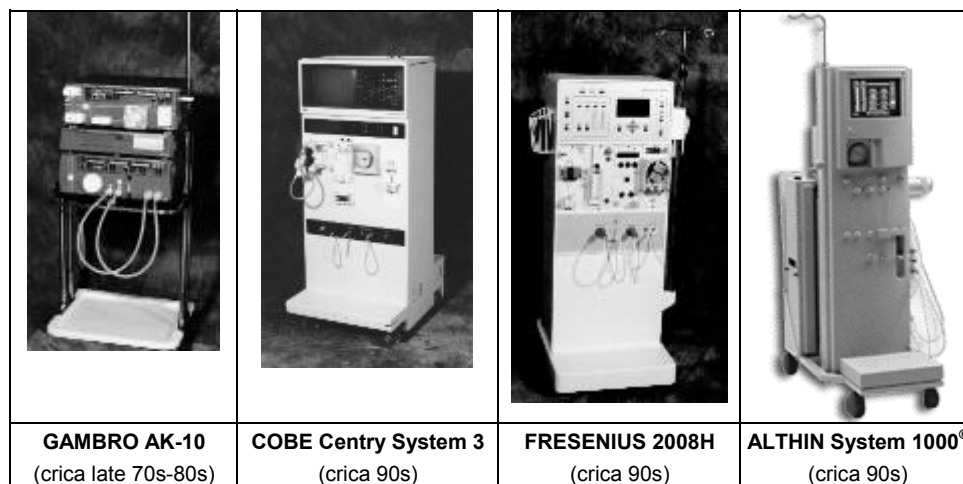

Figure 7. Examples of Computerized HD Machines

#### 3-4.1 Equipment for home use

In 1960s, problems arose due to the lack of money, equipment and trained clinicians, directly as a consequence of the increasing numbers of HD patients. Self-dialysis in the hospital was thus introduced in addition to home dialysis. Home dialysis soon attracted both considerable interest and criticism. Due to the lack of HD machines, numerous clinicians and engineers began building HD machine by themselves. For example, Dr. Yuki Nose had treated a patient at home using a coil

dialyser in a domestic electric washing machine in 1961 in Japan [5]. In the USA, Dr. Delanco [13] stated that their first equipment for home dialysis was “a 100-litre device, which looked like a washing machine and had to be filled with water and dialysate by hand at the start of the treatment. The fluid was warmed by a heater and conductivity and temperature were tested by the patient ... the patient emptied the bath, refilled it and tested it again.” The patient had to be very alert during the entire treatment. There was therefore an urgent need for an appropriate home dialysis machine. Consequently, this was one of the reasons for the decrease in the use of home HD.

Specific home HD equipment however continued to be designed and built by numerous clinicians devoted to this modality. For example, a ‘one-button’ machine designed by the University of Washington provided safe and patient-friendly operation for home patients. As the revival of home HD, the design of a new ‘fail-safe’ machine has just been initiated in the US.

### 3-4.2 Portable machine

Inconvenience and immobility were identified as one of the major concerns by patients. A large quantity of dialysate, which includes a large volume of pre-treated tap water, is required for the HD process. This constitutes the main factor for the immobility of the HD machines as both water supply and drainage connections are required. Attempts have been made to construct a portable or wearable dialysis machine, such as Kolff’s wearable kidney [33] and Friedman’s suitcase kidney [6]. Although the use of such devices was suggested by Delanco [14] as ‘warranted’, most of them were a compromise, not fulfilling the ideal of a truly wearable and effective artificial kidney. These devices only achieved limited usage, in contrast to the novel portable/wearable PD technique CAPD in 1976.

The REDY System (Recirculating Dialysis System) changed the basic dialysis concept through its regeneration of the dialysate to achieve a semi-portable system. This equipment does not need fixed water and drain connections, which make travelling possible for patients. The problems of transportation still occur due to a large number of heavy accessories, such as dialysers and bags. Cost is also a major concern which limits its more widespread application.

### 3-4.3 Blood access

Needle access is a major concern expressed by the patients interviewed in Yen’s study [39]. There are a number of approaches to vascular access that can reduce the uncomfortable feelings of patients, including:

- the use of ‘single needle’ vascular access devices which reduce the number of vein-punctures by half.
- the practice of inserting needles into the same site.
- the use of central venous catheters (CVCs) which eliminate the need to use needles at all.

One favorable method was introduced in late 1970s and has been described as the ‘buttonhole (constant-site)’ method of dialysis [34, 35]. This method holds great promise as it could increase the reliability of insertion and the life of the fistula, together with the decrease of the pain on insertion and the occurrence of aneurysms. Although these devices have been suggested as ‘promising’ for

providing durable vascular access, tissue displacement, infection, thrombosis and sepsis are all major concerns and incidences of these have been reported in evaluation studies [30, 7]. The introduction of ‘duller’ needles, so called ‘buttonhole needles’, may overcome these problems, as these needles with a rounded edge tend follow the established puncture path, whereas sharp needles tend to cut adjacent tissues, enlarge the hole and cause bleeding along the puncture path [34]. However, a more detailed clinical evaluation is required to demonstrate the claimed improvement in clinical efficacy.

Catheter access provides a ‘needleless’ alternative. The use of CVCs and other dual lumen designs for chronic HD, have shown success rates in permanent vessel access as good as or better than conventional fistulas or grafts in recent clinical studies [8]. The major concerns are that thrombosis and obstruction to blood flow by apposition against the vessel wall could occur [27]. Clinicians think that experience with catheters for HD could undergo a similar learning curve to PD catheters in the 1980s, i.e. infectious complications may be decreased by implantation with a reverse tunneling method, similar to that the used for PD. Many modifications have been made to catheters recently which may overcome some of these difficulties, including epithelial cell coatings, thus reducing rejection. The catheters can be inserted into the external or internal jugular vein and recent evidence has suggested that these permanent catheters compare favorably with other methods of secondary vascular access [24].



Figure 8. Buttonhole Method

#### 3-4.4 ‘Fail-Safe’ machine

The purpose of dialysis is not merely to prolong life, but also to facilitate and optimize rehabilitation: to enable individuals with renal failure to continue or resume personally and socially valued activities (e.g. employment, social contacts). self-care dialysis encourages greater patient independence, gives patients more control over their illness and therefore improves their quality of life (QoL) - it is also more cost-effective. Satellite units and minimal care dialysis therefore has become fashionable as a compromise to in-center and home dialysis. To date, there are no home HD machines widely available that would make home HD a feasible alternative. Most existing dialysis

machines are not appropriate for home patients to use and maintain as the machine are designed for skilled maintenance.

A 'fail-safe' machine, named PHD™ system (Personal Hemodialysis System) (Figure 9), is under development by Aksys Ltd to enable patients to carry out HD in a self-care setting, such as the patient's own home on a frequent or daily basis, in order to improve clinical outcomes, reduce costs and enhance the patients' QoL [21, 2]. The blood tubing set has been simplified and telemetric monitoring by remote dialysis staff can be operated by the patient through a computer interface with a touch-sensitive display screen. By the use of a touch sensitive display screen with instructions available on a graphic video display, this system is designed to be less intimidating and easier to use than current HD systems. The use of the 'buttonhole' technique of needle insertion should allow patients to perform dialysis at home without a helper. In addition, this system includes automated system disinfections and dialysate preparation (including a water purification and filtration system for back-filtered dialysate) without any direct water supply connections. Furthermore, numerous improvements have been proposed to overcome the problems that occur in the existing systems. Table 2 demonstrates how the Aksys PHD™ system addresses the drawbacks presented when ESRD patients use conventional systems for home HD. However, current progress or developments towards these goals have not been published at this time. This product is not expected to be commercially available until 2001 and has not yet received any of the required regulatory clearances or approvals.

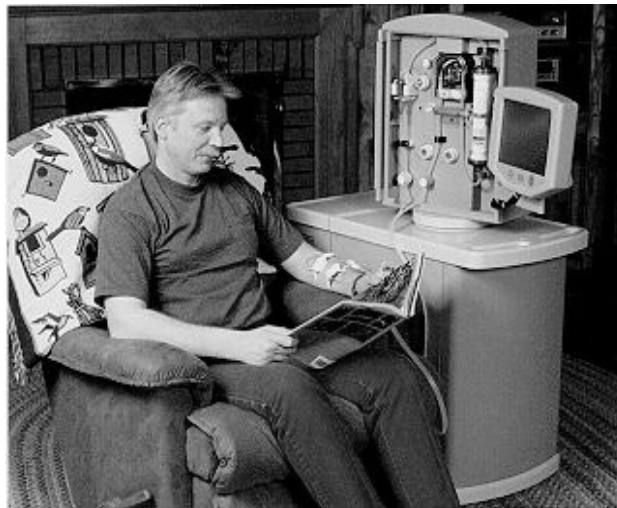

Figure 9. Aksys PHD™ System [2]

## 4. Discussion and Conclusions

### 4-1 The Pattern of Evolution

Table 2 Comparison between Conventional and Aksys PHD™ System in Home Use

Drawback	Conventional Home Systems	Aksys PHD™ System
<i>Complexity</i>	Complicated equipment designed for operation only by trained personnel.	Designed for operation by patients at home through computerised, user-friendly interface.
<i>Time and Effort</i>	Difficult and time consuming to setup, operate, clean and maintain.	Fully automated, requiring minimal patient involvement.
<i>Cost of Consumables</i>	Requires frequent replacement of blood circuit.	Integrated automatic disinfection system designed to enable safe and effective reuse of blood circuit
<i>Clinical Monitoring</i>	Patient treatment compliance monitoring and patient ability to consult with clinic not available unless treatment received in an outpatient facility.	Patient monitored by, and able to communicate with clinic through real time on-line monitoring system.
<i>Partner Involvement</i>	Partner required to operate machine and assist patient.	Designed to be operated solely by patient in most cases.
<i>Storage Requirements</i>	Large volume of consumables and dialysate consumed each month.	Substantially fewer and smaller items consumed with each treatment.
<i>Transportability</i>	Equipment not easily transportable. Water purification separate from dialysis machine. Patient must arrange to visit local clinic when travelling.	Designed to be easily transportable. All essential components, including water purification system, are integrated within the machine and separable into three modules.

(Source: Aksys [2].)

*“Better designs are held back by the marketing people who fear bringing progressive products to a conservative marketplace ... if it [a medical device] does not look like last year’s machine, they don’t like it.”*

(Rendell-Baker quoted by Wiklund [37], p.123)

The evolution of HD equipment presents the somewhat typical historically led development process of medical equipment (Table 3). The basic concept was invented in the mid-1800s and its introduction to medicine was in the early part of this century as consequence of technology invention. The basic component parts of HD machines developed around the late 1940's/early 1950's. The first commercial HD machine was introduced in 1955 for clinical purposes. The most popular design format, which integrated all components into one package similar to an industrial electronic box, was established in 1972 and has survived virtually unaltered ever since. The market quickly became full of ‘me-too’ products and the actual original clinical rationale were often ignored and restricted the development of more usable and effective treatment alternatives.

The example of the development of the HD machine is a useful case study of these elements at work. Although the mainstreams of invention and innovation were primarily technology-push and clinician-centered or even manufacturer-driven, many radical innovations regarding patient needs were introduced by clinicians who were devoted to improving the quality of live of patients. These designs have started to draw the attention of the medical community. As a result, patient-centeredness products could well become the new focus for further development.

#### 4-2 The Challenges for Design

The concerns of QoL, humanism and consumerism in medicine have brought a new dimension to design. Hence, the challenge for designers engaged in healthcare equipment design is to design

Table 3 Design Evolution of HD Equipment

1861	<b>Invention:</b> Dialysis concept (Thomas Graham)
1913-2000	<b>Concept Divergence:</b> <i>from Abel's artificial kidney to Aksys' 'PHD™' system.</i> The development of dialysis has evolved through many years of trial and error and a great diversity of concepts. The milestones include:
1913	Abel's artificial kidney, which introduced the concept of dialysis to medicine.
1924	The first human application of HD undertaken by Dr. Hass (Figure 3).
1943	The first practical application in humans (Kolff's 'Rotating Drum Dialyser') (Figure 4).
1955	The first commercial HD equipment (Kolff's Twin Coil Dialyser) (Figure 5).
1960	Scribner A-V shunt for long-term vascular access.
1961	The first home HD.
early-1970s	Single needle dialysis.
mid-1970s	Buttonhole access.
Late-1970s	The use of a single/double lumen catheter for blood access.
1990s	The use of daily home HD.
1970-present	<b>Design Convergence:</b> Development, refinement and mass-production of conventional dialysis equipment, in addition to computerization. The milestones include:
1972	Cobe Centry 2: The first integrated machine.
1977	Gambro AK-10: The first computer-controlled dialysis machine.
1970-present	<b>Design Divergence:</b> From the portable or wearable artificial kidney to a range of different dialysis equipment designs. This was a more radical development stage in HD equipment design, e.g.:
1970s	Kolff's wearable artificial kidney & Friedman's suitcase kidney.
1980s	REDY system.
2000s	Aksys PHD™ system.

products that actively promote a sense of well-being and reassurance for patients.

The Althin System 1000® (Figure 7) is currently one of the most 'high profile' models of HD equipment in the world, having received numerous design awards (including Industrial Design Excellence Awards, Gold 1991, International Design Designers Choice, the Gold IDEA Award by Business Week and Innovation and International Design Prize of the State of Baden-Wuerttemberg 1993.). These awards recognized its "excellent use of ergonomics, aesthetics and suitability for use [36]." However, the evidence from this study showed that the responses of patients and clinicians, were not as good as expected [39]. One of reasons behind this is the inappropriate categorization system. For example, medical equipment was included within the same design category by ID magazine as other commercial equipment, such as office equipment. A typical comment from the judging panel is quoted as follows: "Dialysis represents an intrusive and intimidating process to the patient. The Jury was impressed by how through sensitivity to detail and careful organisation, this design reduces the threat and elevates the confidence of the patient. Overall, it's handsome, compact and humane [36]."

The recognition that 'dialysis machines should not accentuate any sense of isolation already felt by a patient receiving treatment' was clearly indicated in the comment. However, this echoes the points of view of Hammer [20], who argues that many in the design profession "spent more time making machines [look] comfortable [sic] than they did addressing the needs of the people who use them - or worse, they were engaged in stylistic excesses without any regard for how the environment worked or what the people who worked in it had to say."

Although patient interviews were undertaken during the design of this particular piece of equipment, their focus was more on the patient as a ‘passive patient’ than as an ‘active participant’. ‘The feeling of helpless’ and ‘the fear of contracting AIDS’ were identified in their patient study. A significant feature introduced in this design is that this machine is designed to be used by clinicians who are standing in front of the machine, regardless of the patients’ position, who most likely sits in a reclining chair alongside the machine (Table 4). Although the designer claims that this feature allows “technicians to concentrate on the control screen and the patient, not the machine [36]”, evidence from observation in Yen’s study [39] demonstrated that this is an inappropriate configuration, as eye movement of the clinicians could not move smoothly around the control panel and the patient, i.e. poor scan sequence due to poor control layout and height of equipment. In addition, confusion occurs when the alarm is sounding due to the inappropriate position of the alarm indicator. Therefore, the interaction between equipment, clinicians and patients as a whole needs to be reconsidered. Industrial design, like other professions, thus needs not only to understand the business side of what the manufacturers are aiming to achieve, but also more importantly, to educate them to make an appropriate choice in creating a better life for people and to help integrate this concept into their overall objective. Thus, it is very important to view patient-centered design as a radically different way of designing healthcare equipment and environments.

Table 4. Physical Dimension of Althin System 1000<sup>®</sup> and Fresenius 2008

	Althin System 1000 <sup>®</sup>	Fresenius 2008
Base (width x depth)	43 x 68.5 cm	50.5 x 55 cm
Height	152 cm (up to 2010 cm with IV pole)	114 cm
Weight	approx. 98 kg	approx. 85 kg
Price	approx. £15,000 (ex VAT)	

#### 4-3 Concluding Summary

The evidence gathered from the case studies suggests the following:

- The treatment of kidney failure is one of the most successful and beneficial applications of modern medical science. HD and its ‘symbolic icon’ the HD machine, enables the patient to augment/replace a bodily function. However, it also serves to demonstrate the patient’s inability to control and live with this new patient/machine interaction. An ambivalent attitude may be developed by the patient toward the machine, characterized by a feeling of being controlled by the machine particularly during long term treatment, which could possibly extend to the rest of their life.
- The story of HD equipment demonstrated that the design of HD equipment should be influenced not only by technology-push or/and market-pull but also by the needs of the patients or clinicians.
- There seems to exist a strong compromise between medical treatment and the design of associated equipment in terms of medical outcomes, patient needs and cost. Home HD for example, was first introduced due to lack of financial support and available equipment in hospitals, but it was not

an appropriate modality, at least at that time, for patients. Since then, compromise has also occurred with the introduction of CAPD and more recently, the introduction of minimal care and satellite unit dialysis.

- Although the equipment is getting ever more complex and sophisticated, the basic configuration of the majority of HD equipment remains similar to that of the 1970s and which may not fulfill the needs of patients.
- Aesthetically, the 'high tech' looking Althin machine is initially preferred by clinical staff and designers as it appears to be more technically efficient. However, the actual performance of the machine is not as good as some other less advanced looking machines.

In conclusion, evidence suggests a radical change is required for the design of HD equipment. Thus for a less 'futable' future of dialysis - a better way for the future - the learned lessons from the patient are the finest basis of discussion for how to get benefits back to the patient.



## Reference

1. Advisory Council for Applied Research and Development (ACARD), 1986, *Medical Equipment*, London: HMSO.
2. Aksys, 1997, "The Aksys Solution", Online, Available: <http://www.aksys.com/THEAKSYSSOLUTION.html> (cited 20.06.98).
3. Brundage, D. J., 1992, *Renal Disorders*, St. Louis, Missouri: Mosby Year Book.
4. Boag, J. T., 1996, "Hemodialysis Equipment", *Dialysis & Transplantation*, 26(10), October, pp.697-699.
5. Blagg, CR and Milloux, LU, 1996, "Introduction: The Case for Home Hemodialysis", *Advances in Renal Replacement Therapy*, 3(2), April, pp.96-98.
6. Briefel, G. R., Hutchisson, JT, Glonsky, RS, Hessert, RL & Friedman, EA, 1975, "Compact Travel Hemodialysis System", *Proc Clin Dia Transplant Forum*, 5, p.61.
7. Bonalumi, U, Simoni, GA, Friedman, D, Borzone, E, Griffanti-Bartoli, F, 1984, "Initial Experience with Hemosite Vascular Access Plant", *Proceedings of the European Dialysis and Transplant Association - European Renal Association*, vol 21, p.262.
8. Bibson, SP and Mosquera, D, 1991, "Five Years Experience with the Quinton Permcath for Vascular Access", *Nephrology Dialysis Transplantation*, 6, pp.269-274.
9. Czaezkes, JW and De-Nour, AK, 1978, *Chronic Hemodialysis as a Way of Life*, New York, NY: Brunner.
10. Cody, T, 1996, *Innovating for Health: The Story of Baxter International* (Online), Available: <http://www.baxter.com> (cited 05.10.97)
11. Cheng, E, 1991, "Hemodialysis - A History: Evolution of a Way of Life, Part 1", *Dialysis & Transplantation*, 20(12) December, pp.742-755.
12. Drukker, W, 1989, "Haemodialysis: A Historical Review", in Maher, JF (ed.), *Replacement of Renal Function by dialysis*, 3rd edit., Dordrecht, Holland: Kluwer Academic Publishers, pp.20-86.
13. Delano, BG, 1996, "Home Hemodialysis", *Dialysis & Transplantation*, 26(10), October, pp.728-729.
14. Delano, BG, 1989, "Regular Dialysis Treatment", in Maher, Op. cit., p.669-686.
15. Evans, RW, Maninen, DL, Garrison, LP, Jr, Hart, G, Blagg, CR, Gutman, RA, Hull, AR & Lowrie, EG, 1985, "The Quality of Life of Patients with End-Stage Renal Disease", *New England Journal of Medicine*, 312(9), Feb. 28, pp.553-559.
16. Fulford, KWM, Ersser, S & Hope, P, (eds.), 1996, *Essential Practice in Patient-Centred Care*, Oxford: Blackwell Science.
17. Gerteis, M, Edgman-Levitan, S, Daley, J & Delbanco, TL (eds.), 1993, *Through the Patient's Eyes*, San Francisco, CA: Jossey-Bass.
18. Gurklis, JA and Menke, EM, 1988, "Identification of Stressors and Use of Coping Methods in Chronic Hemodialysis Patients", *Nursing Research*, 37(4), July/August, pp.236-239, 248.

19. Gurklis, JA and Menke, EM, 1995, "Chronic Hemodialysis Patients' Perceptions of Stress, Coping and Social Support", *ANNA Journal*, 22(4), August, pp.381-388.
20. Hammer, T, 1992, "High-Tech Humanism", *Interiors (US)*, March, p.45.
21. Kenley, RS, 1996, "Tearing Down the Barriers to Daily Home Hemodialysis and Achieving the Highest Value Renal Therapy Through Holistic Product Design", *Advances in Renal Replacement Therapy*, 3(2), April, pp.137-146.
22. Moore, N and Komras, H, 1993, *Patient-Focused Healing: Integrating Caring and Curing in Health Care*, San Francisco: Jossey-Bass.
23. MacKenzie, S, 1995, "Design Counsel", *Hospital Equipment & Supplies*, Sep., p.11.
24. Mosquera, DA, Gibson, SP & Goldman, MD, 1992, "Vascular Access Surgery: A 2-Year Study and Comparison with the Permcath", *Nephrology Dialysis Transplantation*, 7, pp.1111-1115.
25. Pugh, S, 1991, *Total Design, Integrated Methods for Successful Product Engineering*, Wokingham: Addison-Wesley Publishing.
26. Parsons, FM, 1978, "Introduction", in Anderton, JL, Parsons, FM & Jones, DE, *Living with Renal Failure*, Lancaster: MTP Press, pp.1-4.
27. Porteous, C, 1994, "Vascular Access", in Briggs et al. *Op. cit.*, pp.135-154.
28. ReVelle, JB, Frigon, NL & Jackson, HK, 1995, *From Concept to Customer: The Practical Guide to integrated Product and Process Development and Business Process Reengineering*, New York: Van Nostrand Reinhold.
29. Rogers, CR, 1951, *Client-Centered Therapy: Its Current Practice, Implications and Theory*, London: Constable.
30. Reed, WP, Light, PD, Sadler, JH & Ramos, E, 1984, "Alternative Vascular Access in Patients Lacking Veins for Standard Arteriovenous Fistulae", *Proceedings of the European Dialysis and Transplant Association - European Renal Association*, vol 21, p.257.
31. Stewart, M, Brown, JB, Weston, WW, McWhinney, IR, McWilliam, CL & Freeman, TR, 1995, *Patient-Centered Medicine, Transforming the Clinical Method*, Thousand Oaks, CA: Sage Publications.
32. Schers, P, 1992, *Environmental Design Quality in Health*, Manchester: Arts for Health.
33. Stephen, RL, Jacobsen, SC, Atkin Thor, E & Kolff, WJ, 1975, "Portable Wearable Artificial Kidney (WAK), - Initial Evaluation", *Proceedings of the European Dialysis and Transplant Association - European Renal Association*, vol 12, p.511.
34. Twardowski, ZJ, 1995, "Constant Site (Buttonhole) Method of Needle Insertion for Hemodialysis", *Dialysis & Transplantation*, 24(10), October, p.559, Available: <http://www.eneph.com/html/Archives/vascularaccess/v24n10p559.html> (cited 02.04.98).
35. Twardowski, ZJ and Harper, G, 1997, "Buttonhole Method of Needle Insertion into Arteriovenous Fistulas", Online, A Talk in The 3rd International Home Hemodialysis Symposium, Available: <http://www.hdcn.com/symp/homehd/harper.htm> (cited 21.03.98).
36. Vossoughi, S, 1991, "Life-Saving Simplicity, Darke Willock System 1000 Dialysis Machine", *Innovation*, Fall, pp.43-45.

37. Wiklund, ME, 1995, Medical Device and Equipment Design: Usability Engineering and Ergonomics, Buffalo Grove, IL: Interpharm.
38. Yin, RK, 1989, Case Studies Research, Newbury Park, CA: Sage Publication.
39. Yen, CC, 1998, The Application of Patient-Centred Principles to the Design of Medical Equipment through Industrial Design Practice, PhD Thesis, Birmingham: The University of Central England in Birmingham.

## **Acknowledgment**

This paper is derived from a research program (H048) entitled “Cases Design for the Application of Design Management to Medical Equipment Design” funded under the Program for Promoting Academic Excellence of Universities by Ministry of Education.

# 以病人為中心的設計： 洗腎機設計沿革為例之個案研究

顏慶全\* Martin S. Woolley\*\*

\* 新加坡國立大學建築系  
e-mail:akiyc@nus.edu.sg

\*\* 英國倫敦大學 Goldsmiths 學院設計系  
e-mail:martin@mwoolley.demon.co.uk

## 摘要

本研究的目的是探討「以病人為中心 (Patient-Centeredness)」之設計原則，對醫療產品設計之影響。因為使用面包含家中到醫院，醫護人員及病人皆可自行操作機器之可行性，洗腎機 (Hemodialysis) 因此被挑選為個案進行相關研究，以探討以病人為中心與傳統「以醫生為中心 (Clinician-Centered)」之設計成果之差別。從洗腎機的設計發展過程故事中顯示洗腎機的設計不僅要受到科技發展及市場需求的影響，在設計時更需要考慮病人及醫療人員之需求。研究的成果確認以病人為中心之設計理念的合理性及在洗腎機設計沿革上的影響。最後，研究建議洗腎機需要更創新的改革：如何透過學習病人的心得回饋在設計上，以提供病人更大的利益，讓洗腎病患有一個更美好的未來。

關鍵詞：洗腎機、以病人為中心的設計、使用者需求、產品設計、個案研究